

Capsule pressure gauges for chemical applications

EN 837-3



1



- With zero correction
- Robust stainless steel housing (with bayonet bezel)
- Wetted parts and movement made of stainless steel
- GOSSTANDART-certified
- ATEX version (optional)

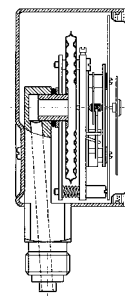

Application For corrosive gaseous and dry media, also for use in corrosive environments.

Technical specifications

Type

D 4

Nominal size

63 – 100 – 160

Accuracy class (EN 837-3/6)

1.6

Ranges (EN 837-3/5)

0/25 to 0/1000 mbar and all corresponding vacuum and compound ranges with overpressure protection

Application area

Static load: full scale value

Dynamic load: 0.9 x full scale value

Overload safety: 1.3 x full scale value

Operating temperature range

Medium: $T_{max} = +100\text{ °C}$ Ambient: $T_{min} = -20\text{ °C}$ $T_{max} = +60\text{ °C}$

Temperature performance

Indication error when the temperature of the measuring system deviates from the normal temperature of 20 °C:

rising temperature approx. $\pm 0.6\text{ %}/10\text{ K}$ falling temperature approx. $\pm 0.6\text{ %}/10\text{ K}$ of full scale value

Degree of protection

IP 32 (EN 60529)

Standard version

Connection

Stainless steel 316 Ti/316 L, bottom or centre back

NG 63 G $\frac{1}{4}$ B – spanner size SW 14

NG 100 – 100 G $\frac{1}{2}$ B – spanner size SW 22 (EN 837-3/7.3)

Measuring element

Capsule element, stainless steel 316 Ti/316 L

Movement

Stainless steel

Zero correction

From the front

Seal

FKM (Viton)

Dial

Aluminium, white

Dial marking black

Pointer

Aluminium, black

Housing

Stainless steel 304

Bayonet type bezel

Stainless steel 304

Window

Laminated safety glass

Panel mounted devices (types D 432/452):

Plastic (PMMA)

Options

- Back flange
- Panel mounting bezel
- 3-hole fixing, panel mounting bezel
- ATEX version 

- Damping screw
- Special scales
- Other process connections

i

See page 19 for prices.

Capsule pressure gauges for chemical applications

Type D 4 – NG 63/100/160

Housing types and dimensions

1

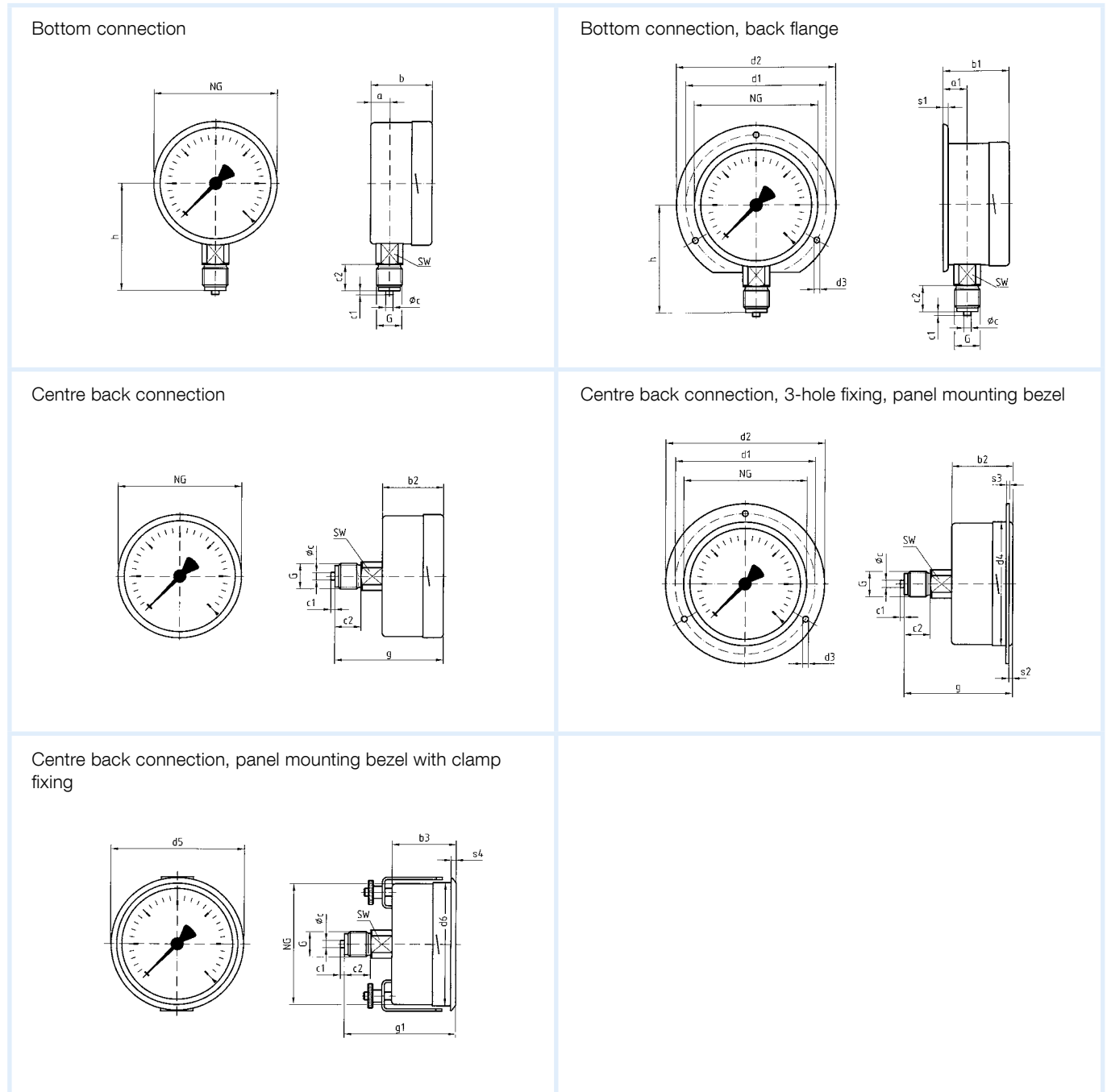

Dimensions (mm)

Nominal size (NG)	a	a1	b	b1	b2	b3	ϕ_c	c1	c2	d1*	d2	d3*	d4	d5	d6	G	g	g1	h	s1	s2
63	10.8	13.4	40	42.1	37	37	5	2	13	75	85	3.5	64	68	64	G $\frac{1}{4}$ B	60	60	53	5.2	3
100	15.6	19.1	49	52.5	49	49	6	3	20	116	132	4.8	104	107	101	G $\frac{1}{2}$ B	81	81	86	5.5	4
160	17.5	20.5	50	53	50	52	6	3	20	178	196	5.8	164	167	161	G $\frac{1}{2}$ B	82	84	116	6	4
Nominal size (NG)	s3	s4	SW																		
63	2	3	14																		
100	2	4	22																		
160	2	4.5	22																		



* Dimensions for NG 100 according to DIN 16014.

Capsule pressure gauges for chemical applications

EN 837-3

DG: M, PG: 3

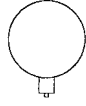
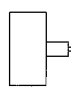
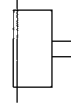
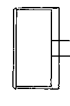
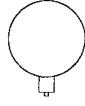
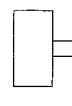
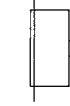
1

Type	KP63Ch, D402	KP63Ch, D412	KP63Ch, D432	KP63Ch, D452	KP100Ch, D402	KP100Ch, D412	KP100Ch, D432	KP100Ch, D452
Version								
Housing Ø	63	63	63	63	100	100	100	100
Housing	Stainless steel 304 with bayonet bezel, window, see data sheet							
Measuring element	Capsule element, stainless steel 316 Ti/316 L							
Accuracy class	1.6	1.6	1.6	1.6	1.6	1.6	1.6	1.6
Connection	G¼B	G¼B	G¼B	G¼B	G½B	G½B	G½B	G½B
			3-hole fixing, panel mounting bezel, 304, polished	Panel mounting bezel 304 with clamp fixing			3-hole fixing, panel mounting bezel 304 polished	Panel mounting bezel 304 with clamp fixing
Range (mbar)	Part no.	Part no.	Part no.	Part no.	Part no.	Part no.	Part no.	Part no.
Price €								
-25/0	35004402	35004412	35004432	35004452	35104402	35104412	35104432	35104452
-40/0	35005402	35005412	35005432	35005452	35105402	35105412	35105432	35105452
-60/0	35006402	35006412	35006432	35006452	35106402	35106412	35106432	35106452
-100/0	35007402	35007412	35007432	35007452	35107402	35107412	35107432	35107452
-160/0	35008402	35008412	35008432	35008452	35108402	35108412	35108432	35108452
-250/0	35009402	35009412	35009432	35009452	35109402	35109412	35109432	35109452
-400/0	35010402	35010412	35010432	35010452	35110402	35110412	35110432	35110452
-600/0	35011402	35011412	35011432	35011452	35111402	35111412	35111432	35111452
-1000/0	35012402	35012412	35012432	35012452	35112402	35112412	35112432	35112452
Price €								
0/25	35016402	35016412	35016432	35016452	35116402	35116412	35116432	35116452
0/40	35017402	35017412	35017432	35017452	35117402	35117412	35117432	35117452
0/60	35018402	35018412	35018432	35018452	35118402	35118412	35118432	35118452
0/100	35019402	35019412	35019432	35019452	35119402	35119412	35119432	35119452
0/160	35020402	35020412	35020432	35020452	35120402	35120412	35120432	35120452
0/250	35021402	35021412	35021432	35021452	35121402	35121412	35121432	35121452
0/400	35022402	35022412	35022432	35022452	35122402	35122412	35122432	35122452
0/600	35023402	35023412	35023432	35023452	35123402	35123412	35123432	35123452
0/1000	35024402	35024412	35024432	35024452	35124402	35124412	35124432	35124452

Minimum order quantity for non-stock items = 10 pieces.

Blue part no. = in-stock items







See page 20 for extra charges.

Capsule pressure gauges for chemical applications

EN 837-3

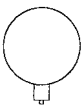
DG: M, PG: 3

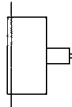
1

Type	KP160Ch, D402	KP160Ch, D412	KP160Ch, D432	KP160Ch, D452
Version				
Housing Ø	160	160	160	160
Housing	Stainless steel 304 with bayonet bezel, window, see data sheet			
Measuring element	Capsule element, stainless steel 316 Ti/316 L			
Accuracy class	1.6	1.6	1.6	1.6
Connection	G½B	G½B	G½B	G½B
			3-hole fixing, panel mounting bezel, 304, polished	Panel mounting bezel 304, with clamp fixing
Range (mbar)	Part no.	Part no.	Part no.	Part no.
Price €				
-25/0	35154402	35154412	35154432	35154452
-40/0	35155402	35155412	35155432	35155452
-60/0	35156402	35156412	35156432	35156452
-100/0	35157402	35157412	35157432	35157452
-160/0	35158402	35158412	35158432	35158452
-250/0	35159402	35159412	35159432	35159452
-400/0	35160402	35160412	35160432	35160452
-600/0	35161402	35161412	35161432	35161452
-1000/0	35162402	35162412	35162432	35162452
Price €				
0/25	35166402	35166412	35166432	35166452
0/40	35167402	35167412	35167432	35167452
0/60	35168402	35168412	35168432	35168452
0/100	35169402	35169412	35169432	35169452
0/160	35170402	35170412	35170432	35170452
0/250	35171402	35171412	35171432	35171452
0/400	35172402	35172412	35172432	35172452
0/600	35173402	35173412	35173432	35173452
0/1000	35174402	35174412	35174432	35174452

Minimum order quantity for non-stock items = 10 pieces.

Blue part no. = in-stock items



See page 20 for extra charges.